

TCL | 40th 



T-PRO

FIT YOUR NEEDS

Innovations

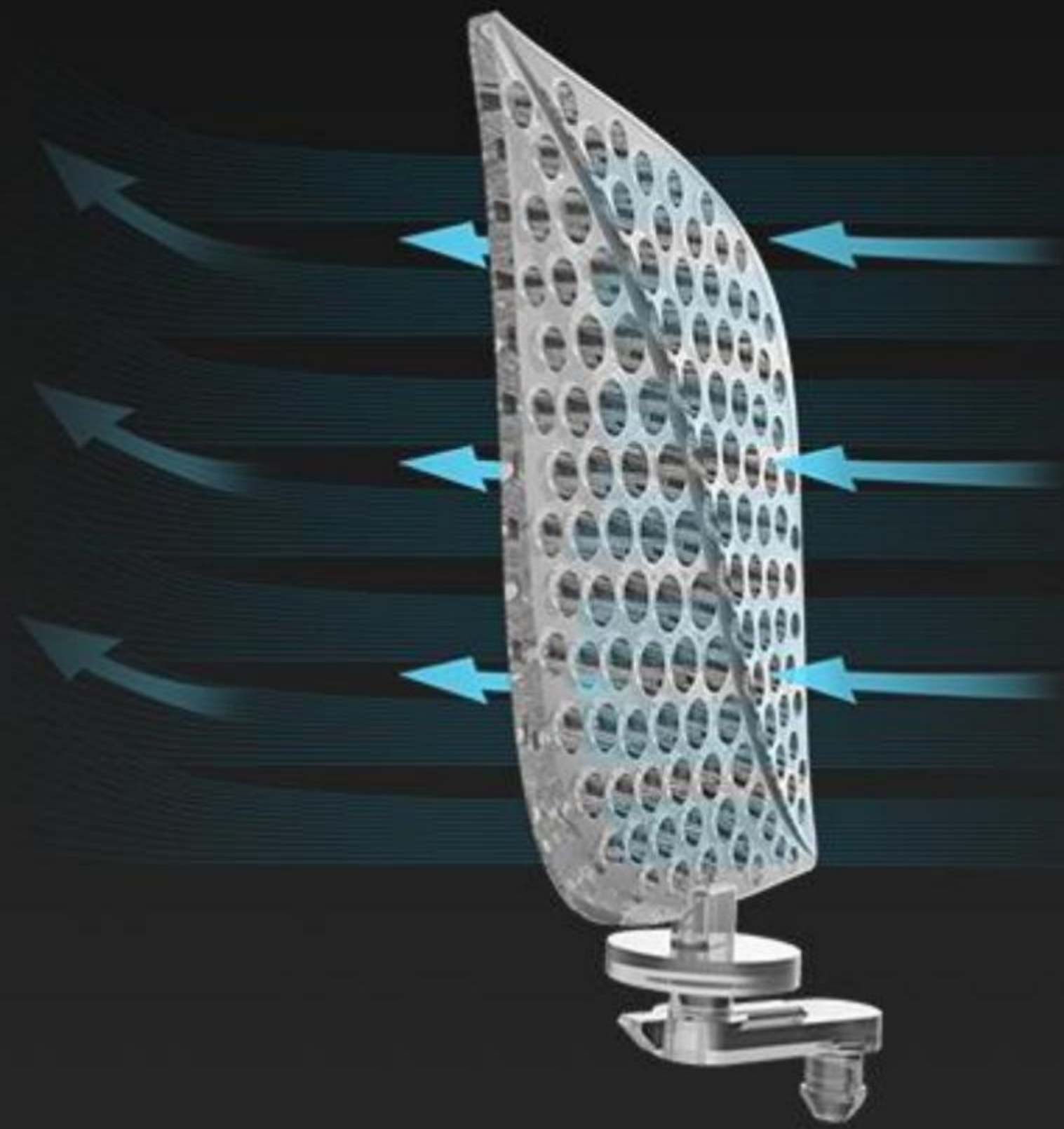

Gentle Cool Wind

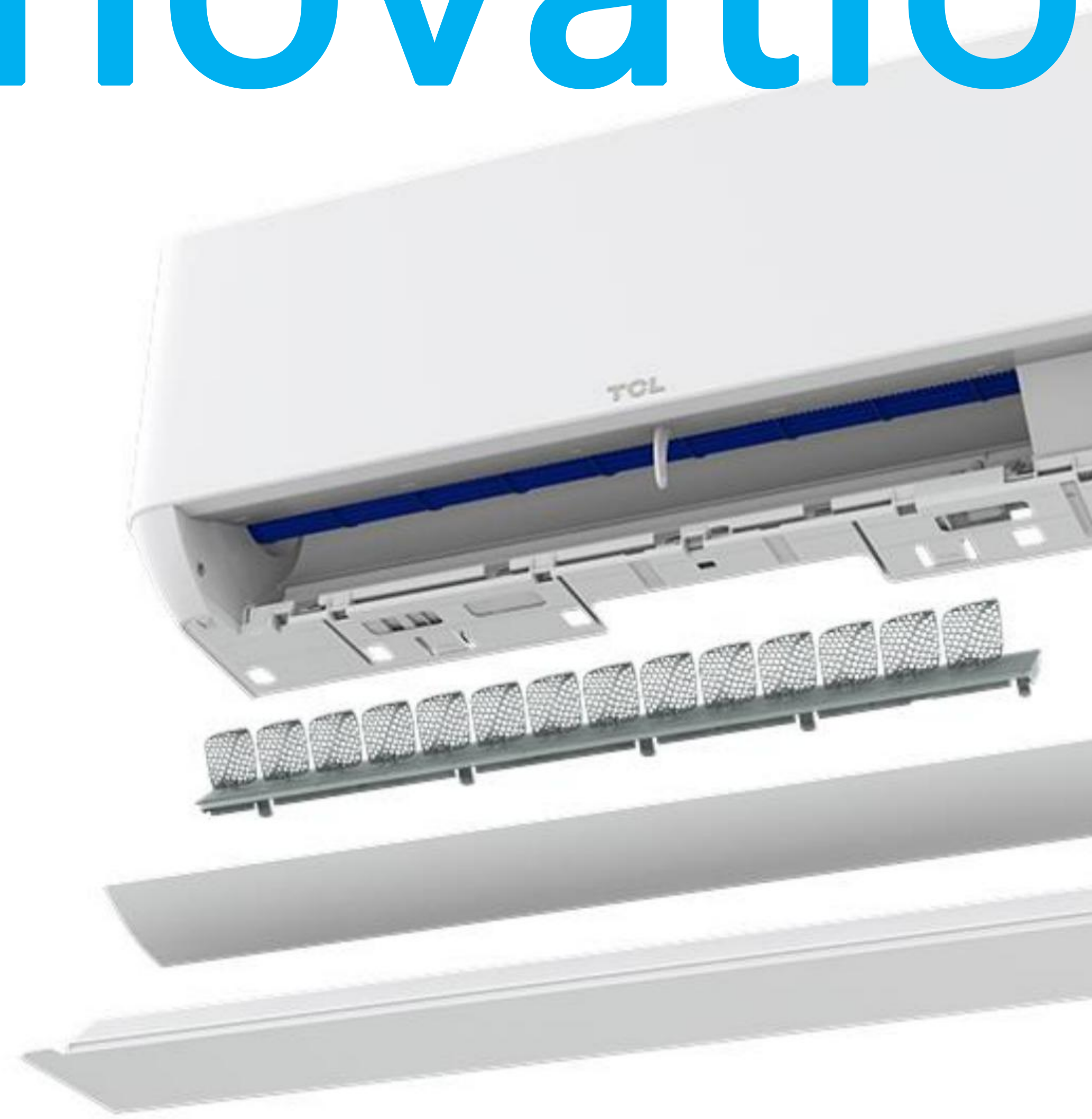

20" = Disassembly + Assembly



Top Opened Filter

Upgrades



Matt Finish Louver

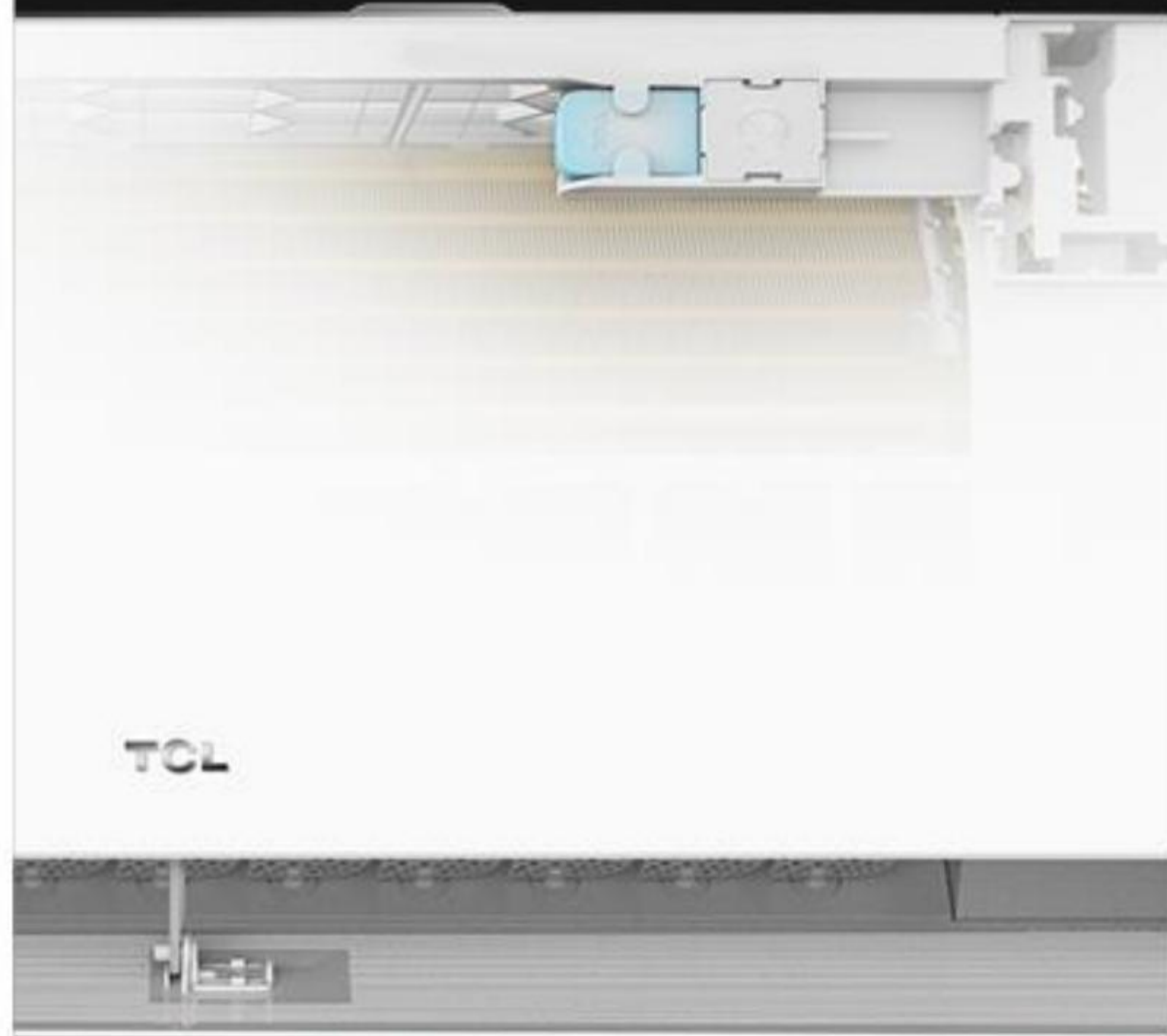

USB WIFI



Smaller Closing Gap



Larger & Stronger

T- PRO FIT USER' S NEEDS

Your Sell-out, We Care

Turbo Cooling

100Hz High Frequency Starting

Rapid Cooling up to 30" *

Air Volume Increased by 20%

Noise Reduced by 1-2 dB(A)

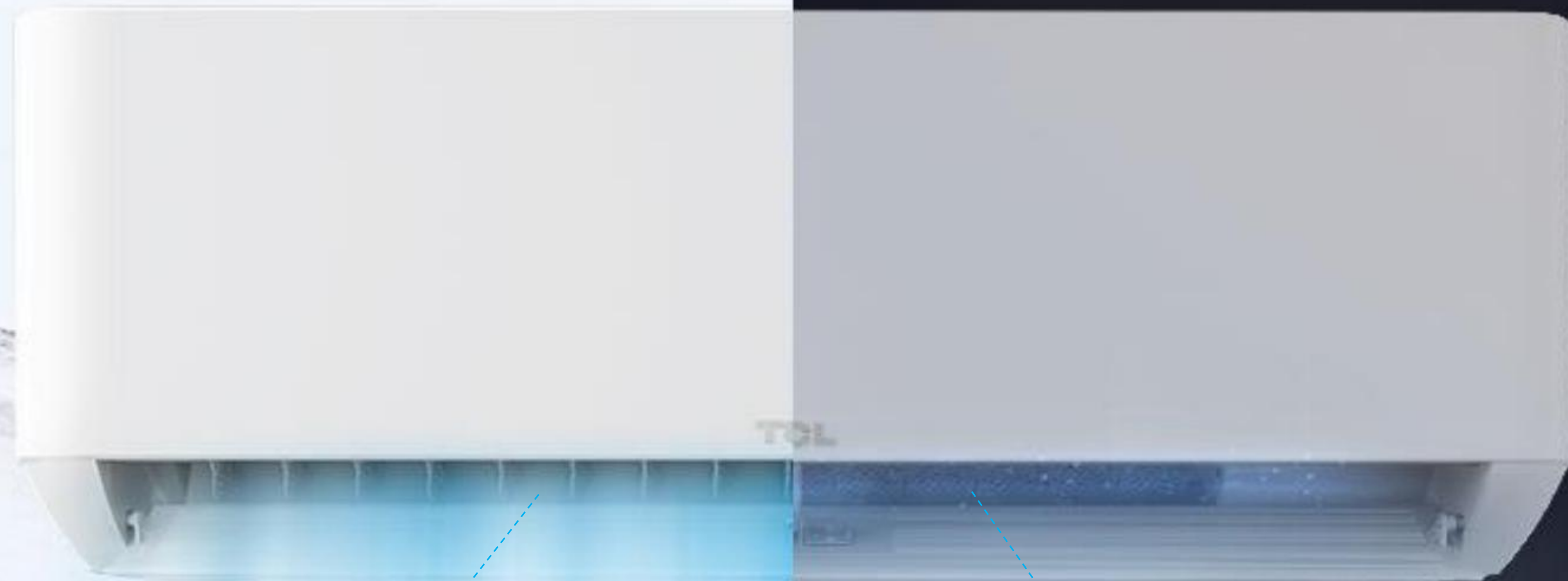

* Data from specific sample under testing condition

Gentle Cool Wind

Gentle cool wind blades



Patent for Invention:

No. 3712066



60°C Strong Cooling in High Ambient Temp



60°C Ambient: Still Good Cooling
50°C Ambient: Full Capacity as Rated

-25°C Strong Heating in Low Ambient Temp



-25°C Ambient: Still Good Heating



* Inverter Only

Distributed Healthy Filter System

Top Opened Filter
Integrated High Density Filter

Healthy Filters *
Multiple Options for Each AC

Singular Filter

-  Silver Ion Filter
-  Active Carbon Filter
-  Catechin Filter

6 IN 1 Filter

-  Photocatalyst Filter
-  Catechin Filter
-  Active Carbon Filter
-  Silver ion Filter
-  Anti-dust static Filter
-  Vitamin C Filter

* Optional

B.I.G. Care

Built- in Bipolar Ionic Generator

- Bipolar Ionic Generator is built in the air outlet
- Release high energy electronics to ionizing the air
- Generate large volume of plasma, atoms, strong oxidization substance, which could damage & kill the bacteria & virus

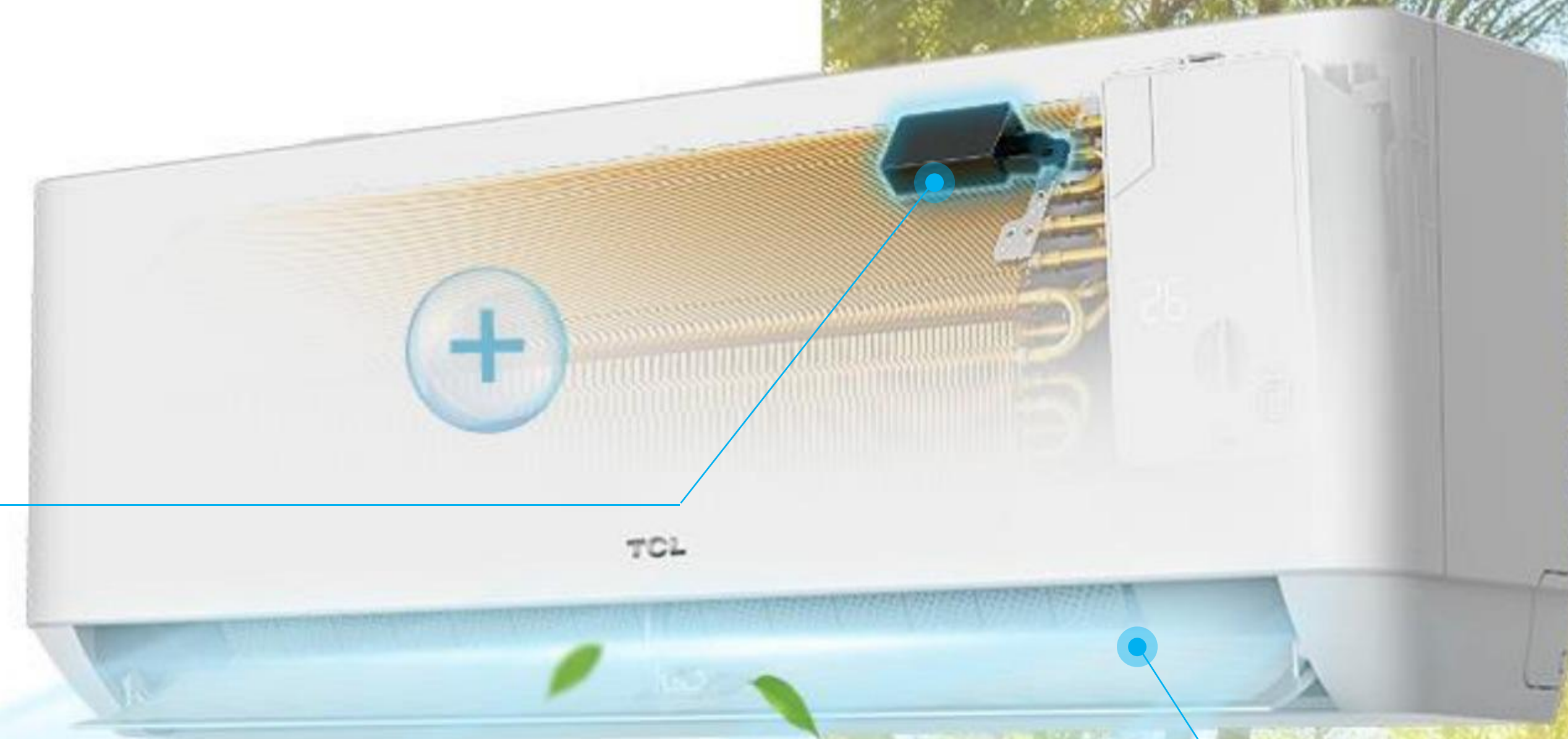

* Optional

56°C High Temperature Self-cleaning & Sterilization



Frosting



Defrosting



High Temperature
Drying



56°C High Temperature
Sterilization

* Heat Pump DC Inverter Only

* Optional



Testing Report

Bacterial Killing Rate: **Up to 93.18%**

Smart Control of Air Conditioner

* Optional



 **USB-WIFI**

 **WIFI Control**
Remote control of the AC.

 **AI Voice Control**
Voice control based on deep neural network.





T. PRO FIT PARTNER'S NEEDS

Your Efficiency, We Care

Easy Installation

Optimized Installation Plate

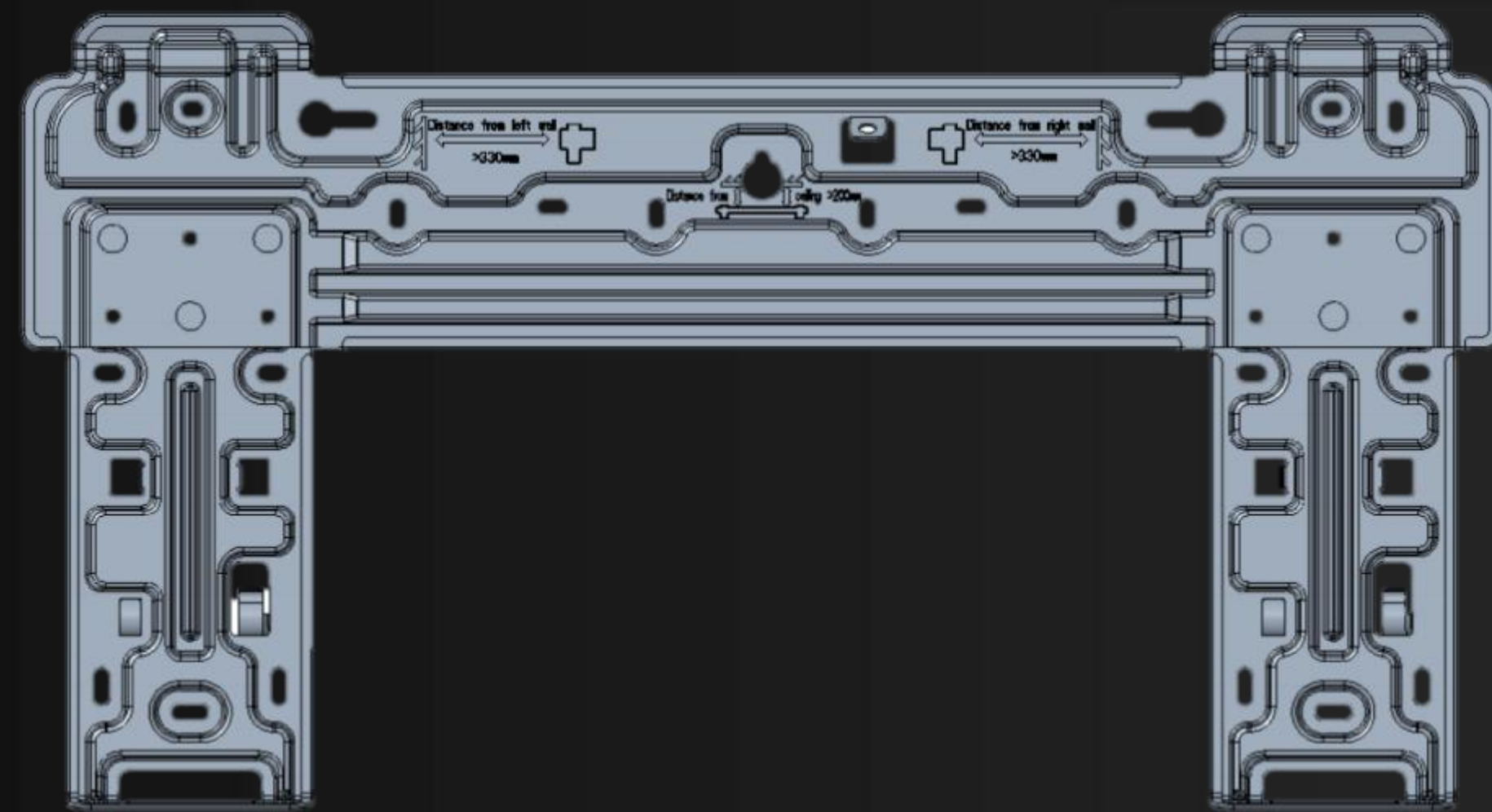

π Design

- Thicker and Stronger

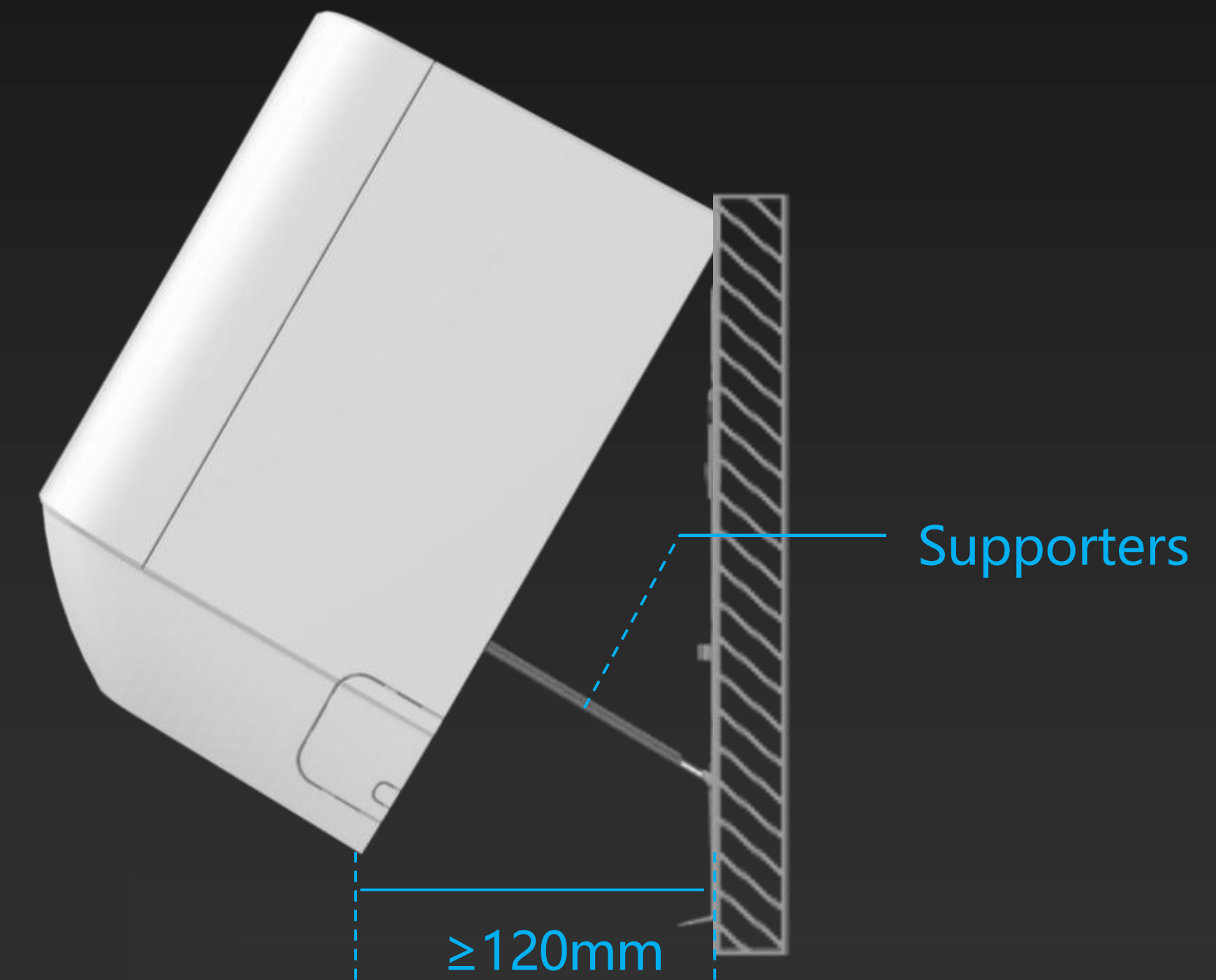

Convenient Installation

- Gap ≥ 120 MM
- Supporters Available

Easy Installation

Easy Detachable Bottom Plate



Larger Space for Piping (10%)



One **PRESS** to Detach the Unit From the Plate

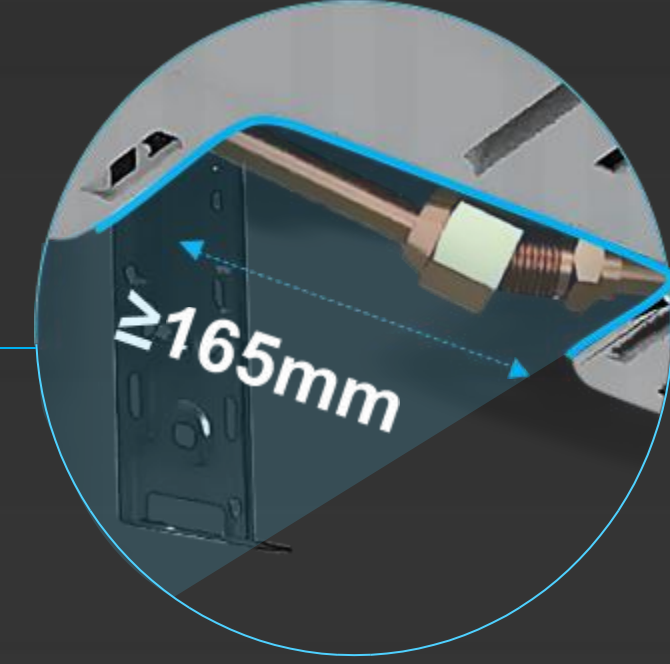

Larger Space for Pipe Connection (≥ 165 mm)



Window for Easy Wiring

Easy Maintenance

Quick Replacement of PCB

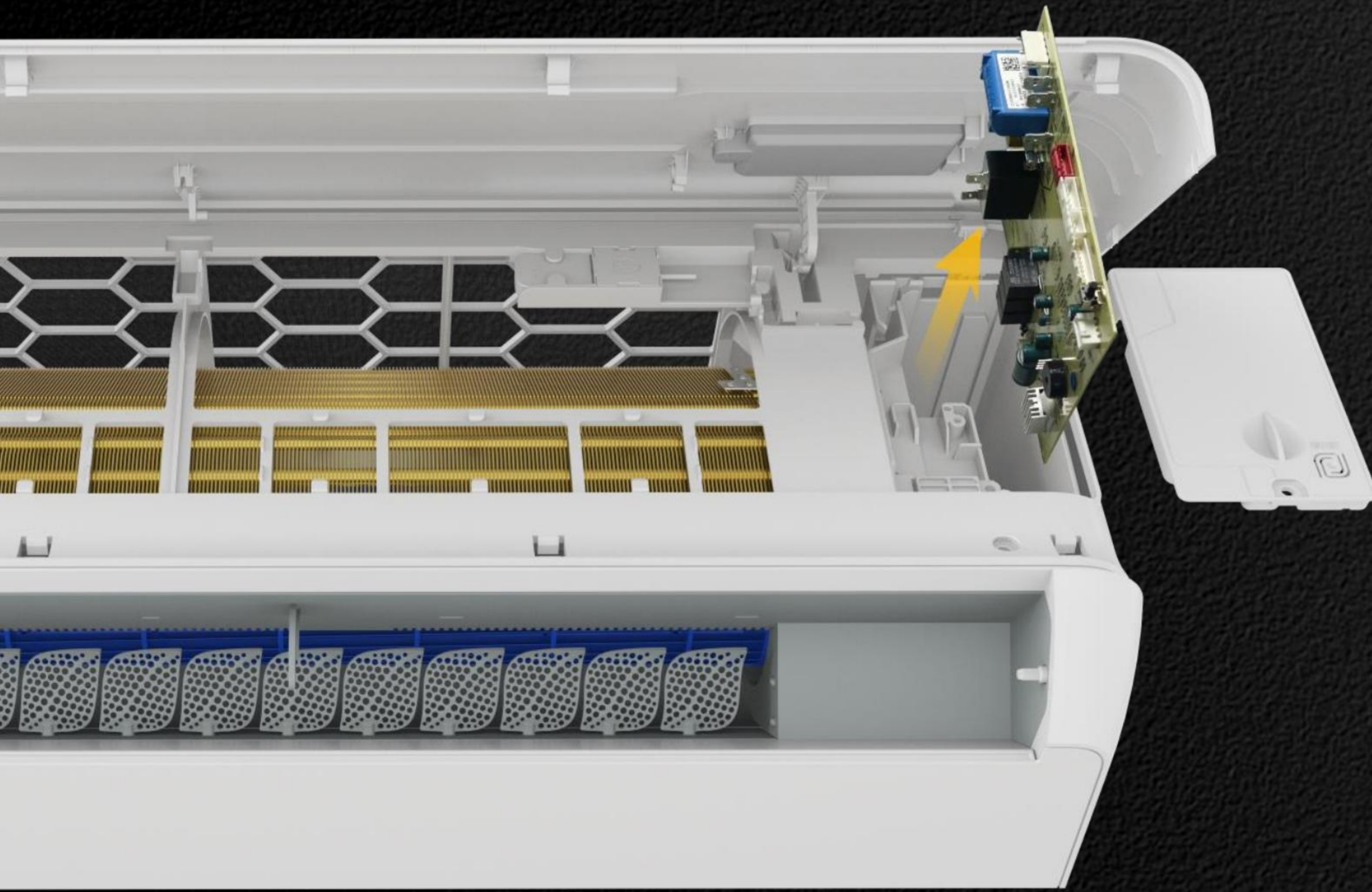

ONLY 3 STEPS

STEP 01

Open front panel

STEP 02

Take off PCB box cover

STEP 03

Take out PCB for replacement



Easy Maintenance Convenient Leakage Check

Large space for connecting
leakage check of indoor unit.

Easy Cleaning Duct System & Cross Fan

Only 3 Steps
Needed for a
Deeper
Cleaning

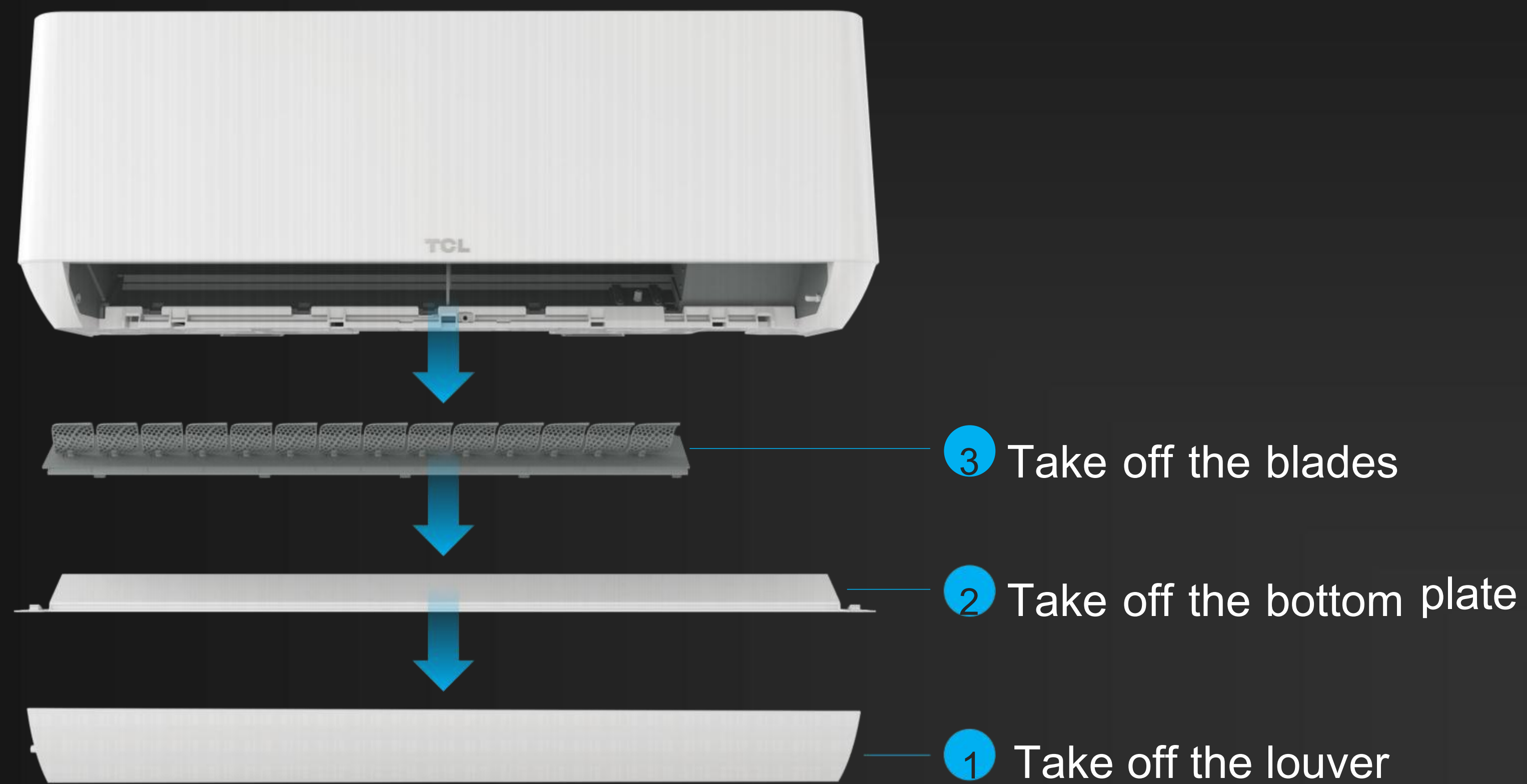

Easy Assembly

20'' = Disassembly + Assembly

No Screw Only Buckles

8''

Disassembly

12''

Assembly

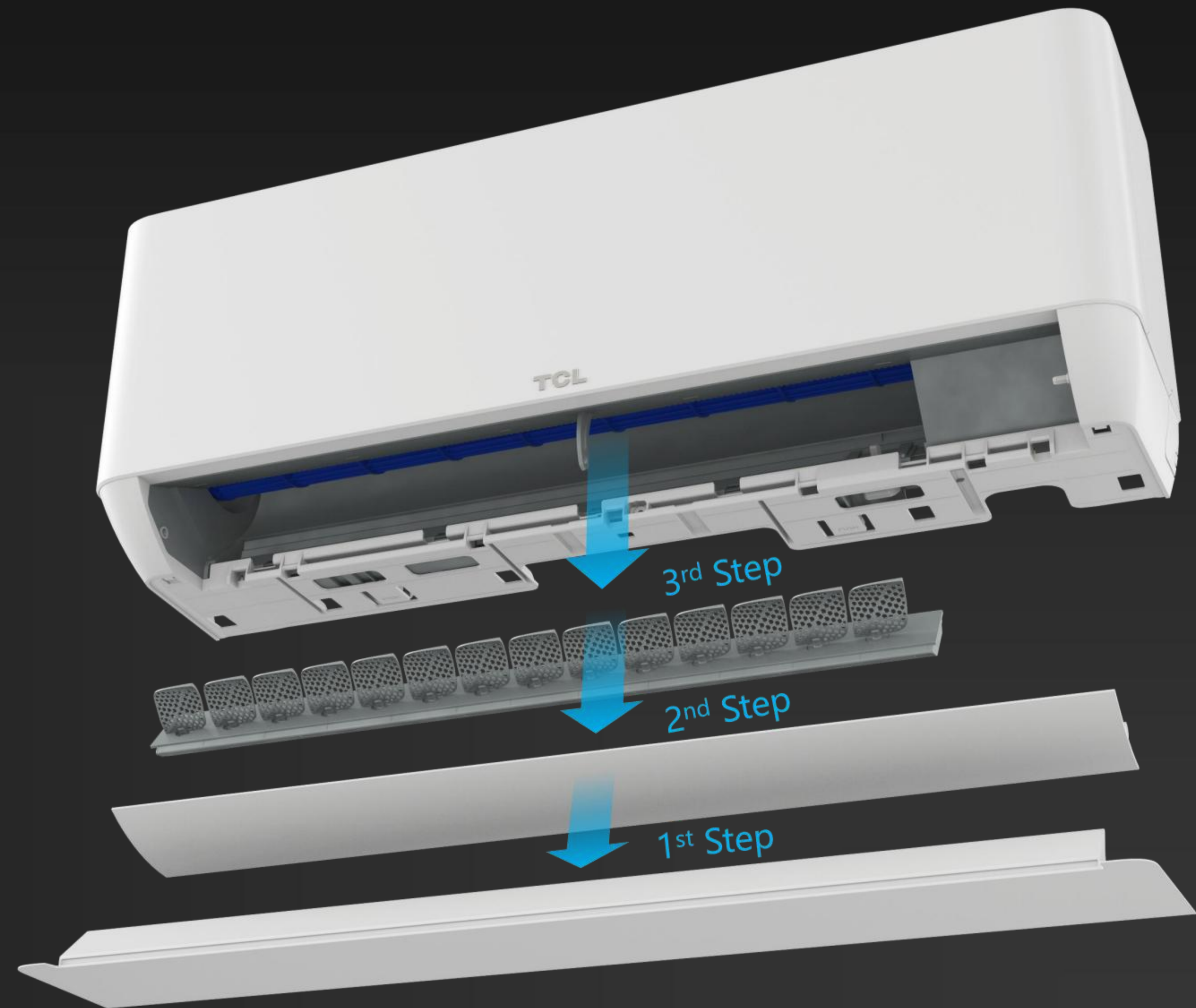

Easy Assembly

Assembly Efficiency Increased up to 12.5%

Less Parts, Less Screws, Less Process

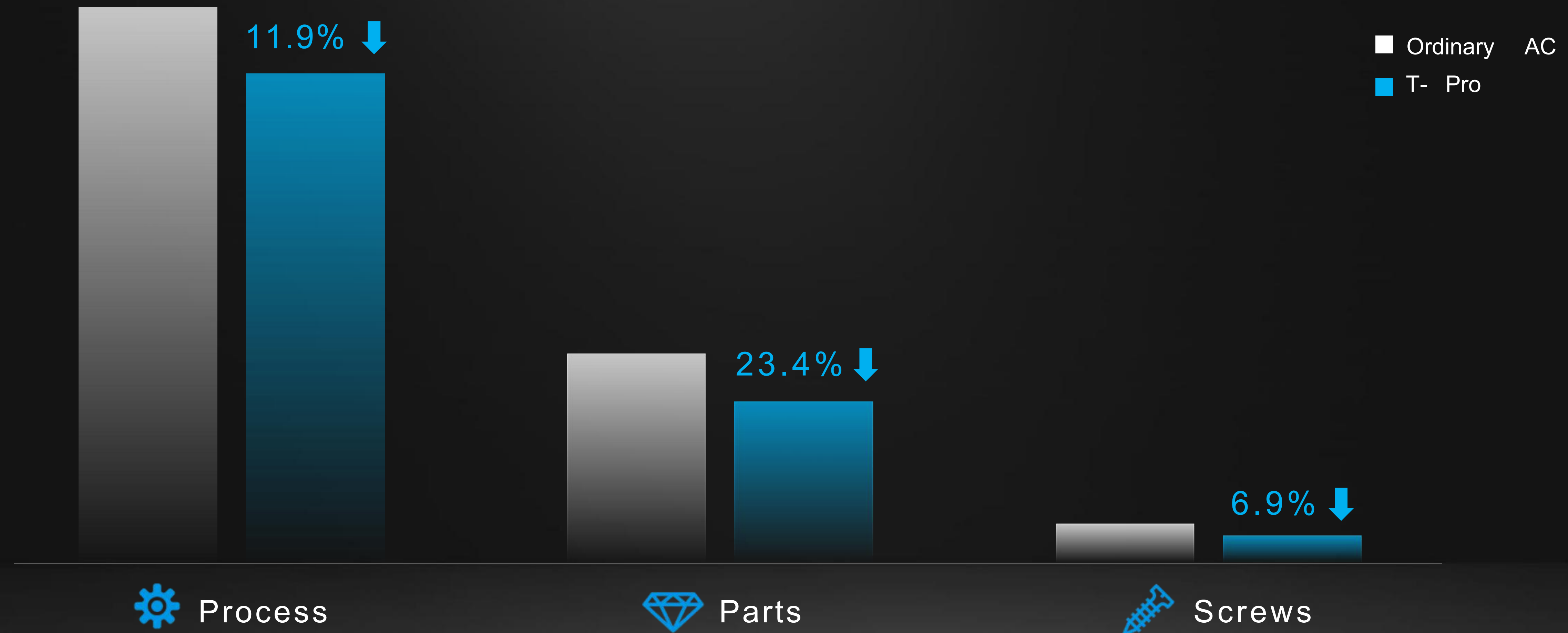

* Take 24K as an example

Function Guide

T-PRO	Emergency Button	Self-diagnosis	BMC Fireproof Electric Box	I Feel	Turbo Mode	Mute Mode	Auto Mode	Independent Dehumidification	Anti-cold	Louver Position Memory	Vertical Swing	Horizontal Swing	Display On/Off	Smart Air Flow	8华 Heating	-50华 Heating	-E0华 Heating	-r己华 Heating	ECO Mode	Sleep Mode	1W Standby	
On / Off	●	●	○	○	○	○	●	●	●	●	●	○	○	●	-	-	-	-	○	●	○	
Inverter	●	●	○	○	○	○	●	●	●	●	●	○	○	●	○	○	○	○	○	○	●	-

T-PRO	One Button Start-up	24H Timer	Auto-restart	Wi-Fi Control	Ionizer	High Density Filter	Special Filter	Aroma Mosquito Repellent	Mildew Proof	Electricity Expenses Management	Ultra-low Energy-saving OFrequencyperation	AI Inverter Algorithm	Vector Precision Air Supply	Strong Cooling in High Ambient Temperature
On / Off	●	●	●	○	○	○	○	○	○	-	-	-	○	-
Inverter	●	●	●	○	○	○	○	○	○	○	○	●	○	○

T-PRO	Rapid Cooling / Rapid Heating	Comfortable Cooling	Photosensitive Control	Filter Cleaning Reminder	己己华 Hipd T9mq916了u19 Self-cleaning	Refrigerant Leakage Detection	I Set	Smart Scenario Control	LED Concealed Display	Celsius and Fahrenheit Degree Switch	Dual Drainage	Golden Fin	Heating Belt	Wire Control
On / Off	-	-	○	-	-	○	○	-	●	○	●	○	-	○
Inverter	○	○	○	○	○	○	○	○	●	○	●	○	○	○



T-PRO

FIT YOUR NEEDS